

Slimline Range

SM 550-FF

Vibratory Check Screener in 550mm Diameter

The 550-FF model can be used as a simple means of check sieving into bins or containers. It is primarily designed to be fed under gravity within new or existing production lines, to screen product into a static weigh bin, big bag, convey line or hopper.

The basic unit will locate within a confined area to provide for retrospective fitting into systems that previously had no sieving equipment. Used with the optional wheeled base assembly, it makes an ideal arrangement to sieve ingredients in small or large batch volumes.

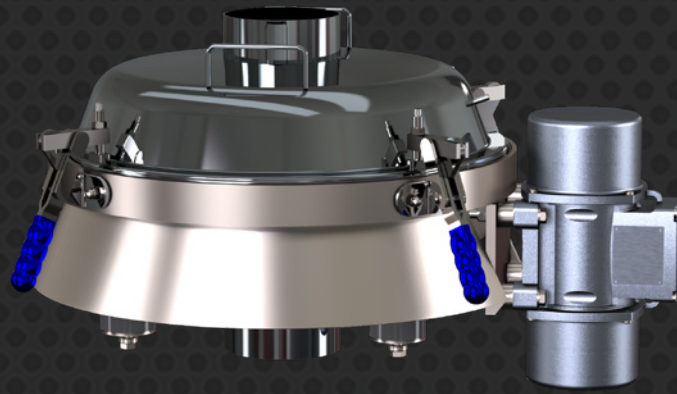

INDUSTRIES



Food & Drink



Pharmaceutical



Chemical



Nutraceutical



Reclamation & Recycling



Additive Manufacturing

FEATURES





- Mobile stands available for greater flexibility, which can be designed to suit installation
- Constructed from FDA compliant materials
- No tool, quick change screens
- Easy clean design, no crevices
- Dust & hose proof IP67
- Noise level less than 70 dBA when in use
- All stainless steel contact parts
- ATEX approved on all sizes as standard
- Can be fitted into sack tipping stations to provide for a dust free, clean operating area
- Vacuum / pressure transfer models available

TYPICAL MATERIALS

- Spices
- Cosmetics
- Seeds
- Most powders / granular products
- Liquid separation
- Flour
- Crystal sugar
- Starch
- Cocoa
- Wet or dry applications

PRODUCT OPTIONS

Machine configurations*

- Open top version with reduced or extended height top gallery 
- Sack tip entry with Safety grid 
- Inlet diaphragm seal 
- Underscreen magnet assy 
- 304SS tubular handles to clamps 
- Upgrade to - Internal: ATEX 20 II
1D External: ATEX 22 II 3D 

- Cone dispersion type inlet 

- Weirflo type inlet 

- Jacob, BFM and Triclamp inlet / outlet 

- Oversize discharge outlet with weir plate 

- Tubular 'C' type frame 

- Ultrasonic upgrade 

- Safety interlock 

Finishes available

- External mirror polish to top gallery <math><0.8Ra</math>
- Dressing of all external welds (with standard mirror polish)
- Pharmaceutical mirror polish <math><0.25Ra</math> & dressing of all external welds
- Passivation after polish
- Vivateq/Sublimotion finish - whole machine
- Upgrade from earth clips to external direct mesh earthing system

CERTIFIED TECHNOLOGY



*More options available on request

Slimline Range

SM 950-ST

Vibratory Check Screener in 950mm Diameter





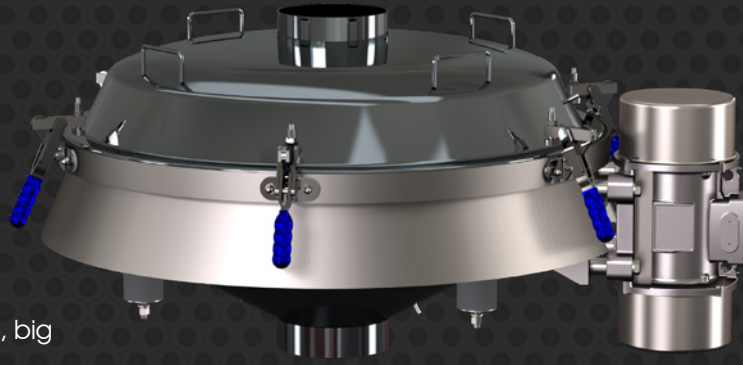







The 950-ST is primarily designed to be fed under gravity within new or existing production lines, to screen product into a static weigh bin, big bag, convey line or hopper.

The 'Slimline' can be located above the inlet to provide an efficient and fast means of ensuring product reliability. The basic unit will locate within a confined area to provide for retrospective fitting into systems that previously had no sieving equipment.



INDUSTRIES						
	Food & Drink	Pharmaceutical	Chemical	Nutriceutical	Reclamation & Recycling	Additive Manufacturing

FEATURES	TYPICAL MATERIALS
<ul style="list-style-type: none"> Can be fitted into sack tipping stations to provide for a dust free, clean operating area Constructed from FDA compliant materials No tool, quick change screens Easy clean design, no crevices Vacuum / pressure transfer models available 	<ul style="list-style-type: none"> Spices Cosmetics Seeds Most powders/ granular products Liquid separation Flour Crystal sugar Starch Cocoa Wet or dry applications
<ul style="list-style-type: none"> Noise level less than 70 dBA when in use All stainless steel contact parts ATEX approved on all sizes as standard Dust & hose proof IP67 	

PRODUCT OPTIONS		Finishes available
Machine configurations* <ul style="list-style-type: none"> Upgrade to - Internal: ATEX 20 II 1D External: ATEX 22 II 3D  304SS tubular handles to clamps  Easy clean drawer magnet assy  Cone dispersion type inlet  Weirflo type inlet  Vision port  	<ul style="list-style-type: none"> Jacob, BFM and Triclamp inlet / outlet  Oversize discharge outlet with weir plate  Support frame assy  Collection bin  Ultrasonic upgrade  Safety interlock  	<ul style="list-style-type: none"> External mirror polish to top gallery < 0.8Ra Dressing of all external welds (with standard mirror polish) Pharmaceutical mirror polish < 0.25Ra & dressing of all external welds Passivation after polish Vivateq/Sublimotion finish -whole machine Upgrade from earth clips to external direct mesh earthing system
<p>*More options available on request</p>		<p>CERTIFIED TECHNOLOGY</p> 

Slimline Range

SM 1250-ST

Vibratory Check Screener in 1250mm diameter

The 1250-ST is primarily designed to be fed under gravity within new or existing production lines, to screen product into a static weigh bin, big bag, convey line or hopper.

This larger unit is technically similar to the SM550/950 models but are designed for very high throughput requirements and have some small design changes due to the size and weight of the components. Maximum consideration is given in the design to ensure these large units can be stripped down by operators.

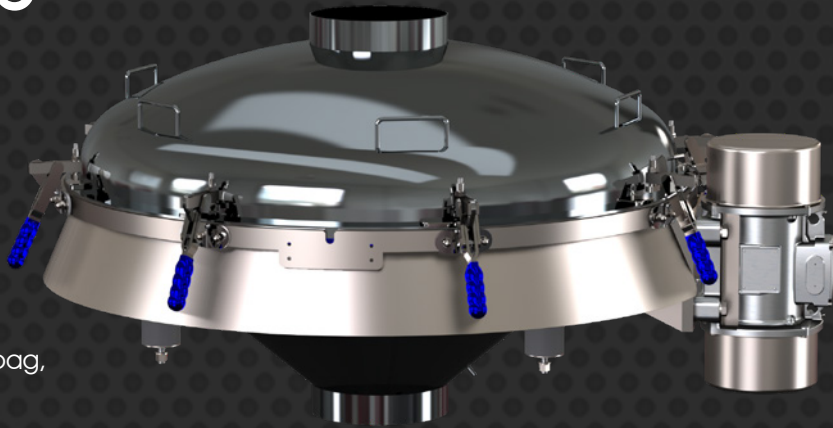

INDUSTRIES



Food & Drink



Pharmaceutical



Chemical



Nutraceutical



Reclamation & Recycling



Additive Manufacturing

FEATURES

- Support frames available, which can be designed to suit installation
- Constructed from FDA compliant materials
- No tool, quick change screens
- Easy clean design, no crevices
- Dust & hose proof IP67

- Noise level less than 70 dBA when in use
- All stainless steel contact parts
- ATEX approved on all sizes as standard
- Vacuum / pressure transfer models available

TYPICAL MATERIALS

- Spices
- Cosmetics
- Seeds
- Most powders/ granular products
- Liquid separation
- Flour
- Crystal sugar
- Starch
- Cocoa
- Wet or dry applications

PRODUCT OPTIONS

Machine configurations*

- Upgrade to - Internal: ATEX 20 II
1D External: ATEX 22 II 3D



- 304SS tubular handles to clamps



- Easy clean drawer magnet assy



- Cone dispersion type inlet



- Weirflo type inlet



- Vision port



*More options available on request

- Jacob, BFM and Triclamp outlet end



- Jacob, BFM and Triclamp inlet end



- Oversize discharge outlet with weir plate



- Support frame assy



- Collection bin



- Ultrasonic upgrade



- Safety interlock



Finishes available

- External mirror polish to top gallery < 0.8Ra
- Dressing of all external welds (with standard mirror polish)
- Pharmaceutical mirror polish < 0.25Ra & dressing of all external welds
- Passivation after polish
- Viwateq/Sublimotion finish -whole machine
- Upgrade from earth clips to external direct mesh earthing system

CERTIFIED TECHNOLOGY



Slimline Range

SM 1550-ST

Vibratory Check Screener in 1550mm Diameter

The 1550-ST is primarily designed to be fed under gravity within new or existing production lines, to screen product into a static weigh bin, big bag, convey line or hopper.

This larger unit is technically similar to the SM550/950 models but are designed for very high throughput requirements and have some small design changes due to the size and weight of the components. Maximum consideration is given in the design to ensure these large units can be stripped down by operators.



INDUSTRIES



Food & Drink



Pharmaceutical



Chemical



Nutraceutical



Reclamation & Recycling



Additive Manufacturing

FEATURES







- Support frames available, which can be designed to suit installation
- Constructed from FDA compliant materials
- No tool, quick change screens
- Easy clean design, no crevices
- All stainless steel contact parts
- ATEX approved on all sizes as standard
- Vacuum / pressure transfer models available
- Noise level less than 70 dBA when in use

TYPICAL MATERIALS

- Spices
- Cosmetics
- Seeds
- Most powders/ granular products
- Liquid separation
- Flour
- Crystal sugar
- Starch
- Cocoa
- Wet or dry applications

PRODUCT OPTIONS

Machine configurations*

- Upgrade to - Internal: ATEX 20 II
1D External: ATEX 22 II 3D 
- 304SS tubular handles to clamps 
- Easy clean drawer magnet assy 
- Cone dispersion type inlet 
- Weirflo type inlet 
- Vision port 

- Jacob, BFM and Triclamp outlet end 
- Jacob, BFM and Triclamp inlet end 
- Oversize discharge outlet with weir plate 
- Support frame assy 
- Collection bin 
- Ultrasonic upgrade 
- Safety interlock 

Finishes available

- External mirror polish to top gallery < 0.8Ra
- Dressing of all external welds (with standard mirror polish)
- Pharmaceutical mirror polish < 0.25Ra & dressing of all external welds
- Passivation after polish
- Vivateq/Sublimation finish - whole machine
- Upgrade from earth clips to external direct mesh earthing system

CERTIFIED TECHNOLOGY



1

2

3

4

5

6

THIRD ANGLE PROJECTION

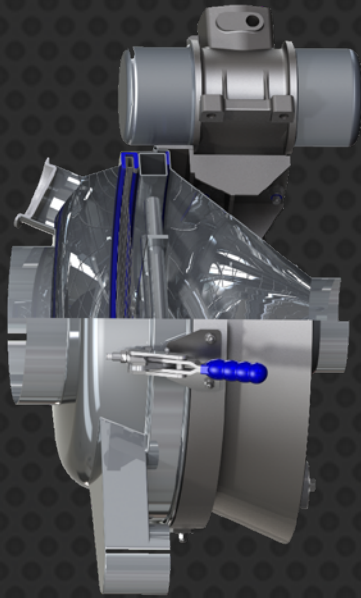
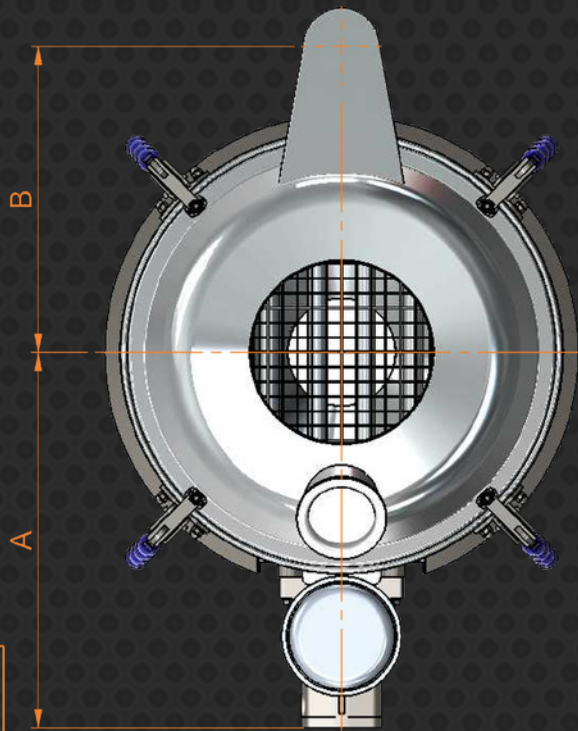

SM SLIMLINE 550-FF & 950-ST

DIMENSION	SM550-FF (mm)	SM950-ST (mm)
A	510	755
B	415	665
C	100 (OPTIONAL)	150 (OPTIONAL)
D	150 - 530	150 - 900
E	100 (OPTIONAL)	100/150 (OPTIONAL)
F	150 - 300	150 - 400
G	400 *	485

SCREEN DIAMETER = 565mm & 965mm

BESPOKE FRAMES AVAILABLE - BFM/JACOB ENDS CAN BE FITTED

*FOR SM550-FF WITH UNDERSCREEN MAGNET ASSY ADD 50mm TO 'G' DIM

ALLOW MIN. 50mm FOR FLEXIBLE CONNECTIONS TO INLET/OUTLET

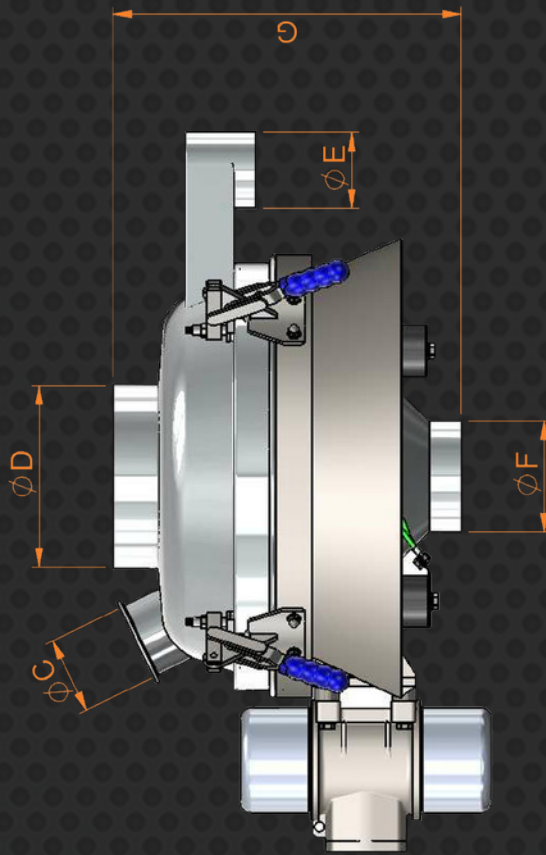

ELECTRICAL	SM550-FF	SM950-ST
VOLTAGE	110 / 240 / 380-460	110 / 240 / 380-460
FREQUENCY	50 / 60 hz	50 / 60 hz
POWER	0.85 kW	0.9 kW
PHASE	1 / 3	1 / 3
ATEX	YES 	YES 

FOR MAGNET OPEN UP GALLERY REFER TO SEPARATE DRAWING

ALL DIMS. ARE APPROX. NOT TO BE USED FOR FINAL PLANNING. FULL DRAWINGS CAN BE SUPPLIED ON REQUEST. SUBJECT TO CHANGE AT ANY TIME.

1

2

3

4

5

6

THIRD ANGLE PROJECTION



SM SLIMLINE 1250-ST & 1550-ST

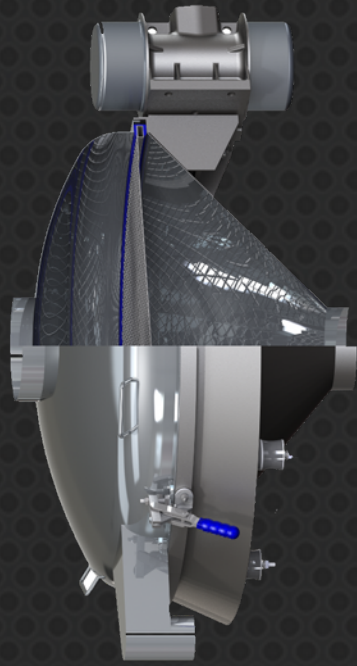
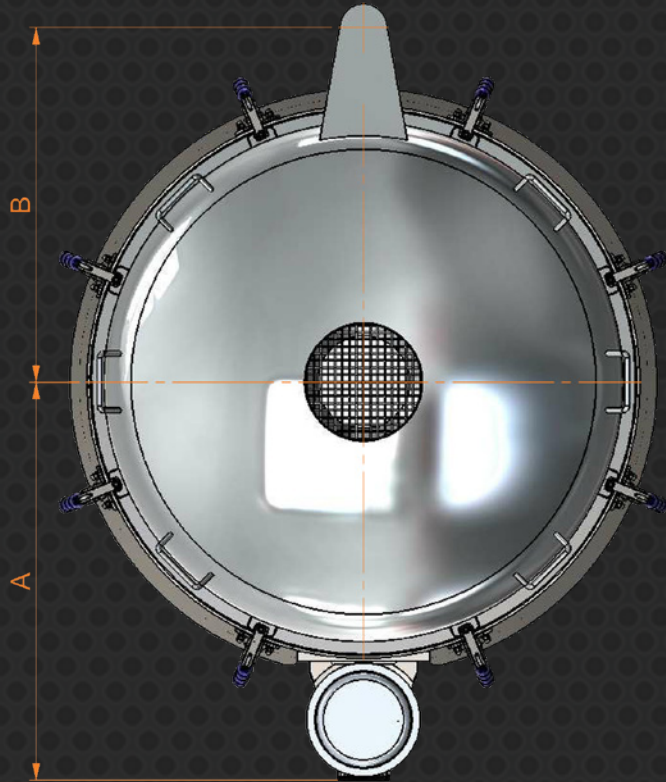

B

DIMENSION	SM1250-ST (mm)	SM1550-ST (mm)
A	842	1000
B	750	980
C	150 - 900	150 - 900
D	150 (OPTIONAL)	150 (OPTIONAL)
E	150 - 600	150 - 600
F	685	1010

C

SCREEN DIAMETER = 1165mm & 1465mm

BESPOKE FRAMES AVAILABLE - BFM/JACOB ENDS CAN BE FITTED

ALLOW min. 50mm FOR FLEXIBLE CONNECTIONS TO INLET/OUTLET

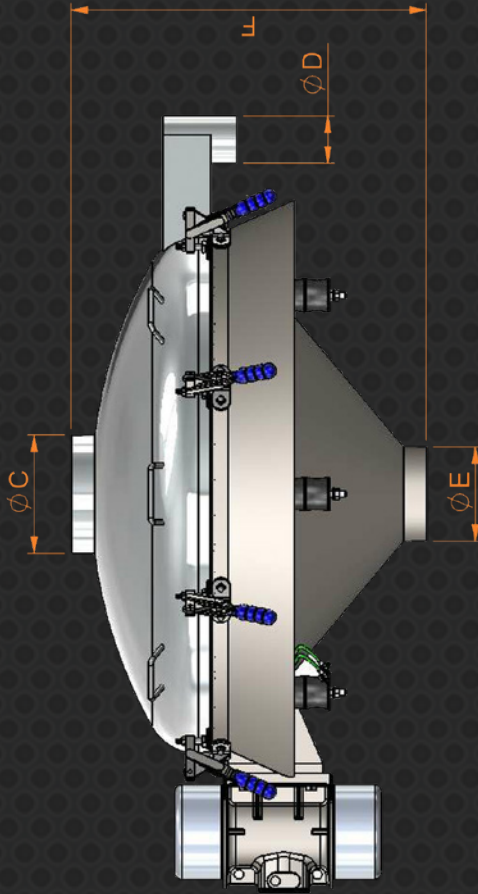

D

ELECTRICAL	SM1250-ST	SM1550-ST
VOLTAGE	110 / 240 / 380-460	110 / 240 / 380-460
FREQUENCY	50 / 60 hz	50 / 60 hz
POWER	0.9 kw	1.1 kw
PHASE	1 / 3	1 / 3
ATEX	YES 	YES 

ALL DIMS. ARE APPROX. NOT TO BE USED FOR FINAL PLANNING. FULL DRAWINGS CAN BE SUPPLIED ON REQUEST. SUBJECT TO CHANGE AT ANY TIME.