

Slimline Multiscreen Range

SM 800

Vibratory Sieve for Grading and Separating

Separate, grade, and sort nearly all types of materials into different sizes, using the Multiscreen vibratory sieve. Its weight configuration technology controls the amount of time product is sat on mesh screens, and the deblinding system eliminates clogging for a consistent throughput and mesh longevity. The Multiscreen can be used in all types of industries and environments and features a quick change mesh system that allows for easy mesh changes and cleaning.

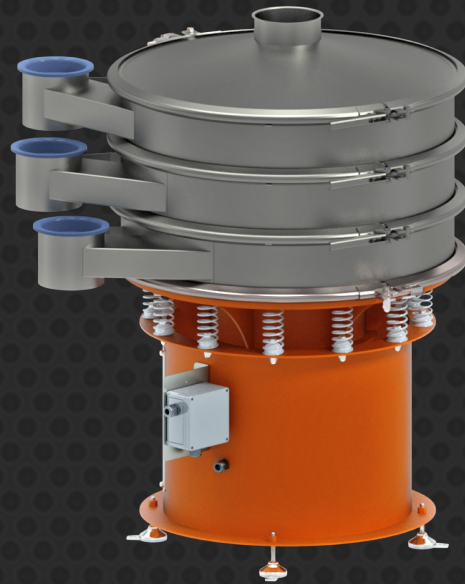

800mm diameter screen for medium throughput applications.

INDUSTRIES



Food & Drink



Pharmaceutical



Chemical



Nutraceutical



Reclamation & Recycling



Additive Manufacturing

FEATURES

- Specially designed frames and extended height bases
- Scroll system for maximum screening efficiency
- Separation of milled or ground products in up to 4 grades in one pass
- Screening of fine powders (e.g. toner powder, metal powders)
- Grading of kibbled or "disintegrated" products
- Constructed from FDA compliant materials
- Quick change bonded screens
- Easy clean design, no crevices
- Quality assured graded end product
- Noise level less than 70 dBA when in use

TYPICAL MATERIALS

- Spices
- Cosmetics
- Seeds
- Liquid separation
- Pharmaceutical powders
- Most powders/ granular products
- Flour
- Crystal sugar
- Starch
- Cocoa
- Wet or dry applications

PRODUCT OPTIONS

Machine configurations*

- Continuous processing of 2 fractions - oversize/fines 
- Continuous processing of 3 fractions - oversize/cut 1/fines 
- Continuous processing of 4 fractions - oversize/cut 1/cut 2/fines 
- ATEX upgrade 
- Enclosed top cover 
- Vision port 

- Intermediate deck dwell control quarter scroll 
- Dwell control full scroll 
- Mesh deblinding - mechanical 
- Mesh deblinding - ultrasonic 
- Mobile base assy 
- Hygiene base assy 
- Hygiene vibro body & suspension 

Finishes available

- Internal mirror polish to galleries (standard < 0.8Ra)
- Dressing of all internal / external welds
- Pharmaceutical mirror polish < 0.25Ra & dressing of all external welds
- Passivation after polish
- Viwateq/Sublimotion finish -whole machine
- Upgrade from earth clips to external direct mesh earthing system

CERTIFIED TECHNOLOGY



*More options available on request

Product Specification

Slimline Multiscreen Range

SM 1200

Vibratory Sieve for Grading and Separating

Separate, grade, and sort nearly all types of materials into different sizes, using the Multiscreen vibratory sieve. Its weight configuration technology controls the amount of time product is sat on mesh screens, and the deblinding system eliminates clogging for a consistent throughput and mesh longevity. The Multiscreen can be used in all types of industries and environments and features a quick change mesh system that allows for easy mesh changes and cleaning.

1200mm diameter screen for high throughput applications.



INDUSTRIES



Food & Drink



Pharmaceutical



Chemical



Nutraceutical



Reclamation & Recycling



Additive Manufacturing

FEATURES







- Specially designed frames and extended height bases
- Scroll system for maximum screening efficiency
- Separation of milled or ground products in up to 4 grades in one pass
- Screening of fine powders (e.g. toner powder, metal powders)
- Grading of kibbled or "disintegrated" products
- Constructed from FDA compliant materials
- Quick change bonded screens
- Easy clean design, no crevices
- Quality assured graded end product
- Noise level less than 70 dBA when in use

TYPICAL MATERIALS

- Spices
- Cosmetics
- Seeds
- Liquid separation
- Pharmaceutical powders
- Most powders/ granular products
- Flour
- Crystal sugar
- Starch
- Cocoa
- Wet or dry applications

PRODUCT OPTIONS

Machine configurations*

- Continuous processing of 2 fractions - oversize / fines 
- Continuous processing of 3 fractions - oversize / cut 1 / fines 
- Continuous processing of 4 fractions - oversize / cut 1 / cut 2 / fines 
- ATEX upgrade 
- Enclosed top cover 
- Vision port 

- Intermediate deck dwell control quarter scroll 
- Dwell control full scroll 
- Mesh deblinding - mechanical 
- Mesh deblinding - ultrasonic 
- Mobile base assy 
- Hygiene base assy 
- Hygiene vibro body & suspension 

Finishes available

- Internal mirror polish to galleries (standard < 0.8Ra)
- Dressing of all internal / external welds
- Pharmaceutical mirror polish < 0.25Ra & dressing of all external welds
- Passivation after polish
- Viwateq / Sublimotion finish -whole machine
- Upgrade from earth clips to external direct mesh earthing system

CERTIFIED TECHNOLOGY



*More options available on request

Product Specification

Slimline Multiscreen Range

SM 1500

Vibratory Sieve for Grading and Separating

Separate, grade, and sort nearly all types of materials into different sizes, using the Multiscreen vibratory sieve. Its weight configuration technology controls the amount of time product is sat on mesh screens, and the deblinding system eliminates clogging for a consistent throughput and mesh longevity. The Multiscreen can be used in all types of industries and environments and features a quick change mesh system that allows for easy mesh changes and cleaning.

1500mm diameter screen for very high throughput applications.

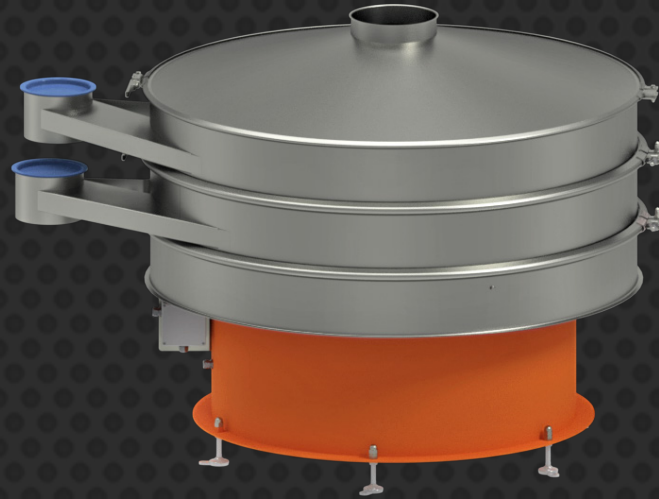

SM sievmaster
by farleygreene

INDUSTRIES



Food & Drink



Pharmaceutical



Chemical



Nutraceutical



Reclamation & Recycling



Additive Manufacturing

FEATURES

- Specially designed frames and extended height bases
- Scroll system for maximum screening efficiency
- Separation of milled or ground products in up to 4 grades in one pass
- Screening of fine powders (e.g. toner powder, metal powders)
- Grading of kibbled or "disintegrated" products
- Constructed from FDA compliant materials
- Quick change bonded screens
- Easy clean design, no crevices
- Quality assured graded end product
- Noise level less than 70 dBA when in use

TYPICAL MATERIALS

- Spices
- Cosmetics
- Seeds
- Liquid separation
- Pharmaceutical powders
- Most powders/ granular products
- Flour
- Crystal sugar
- Starch
- Cocoa
- Wet or dry applications

PRODUCT OPTIONS

Machine configurations*

- Continuous processing of 2 fractions - oversize / fines



- Continuous processing of 3 fractions - oversize / cut 1/fines



- Continuous processing of 4 fractions - oversize/cut 1/cut 2 / fines

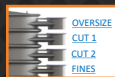

- ATEX upgrade



- Enclosed top cover



- Vision port



- Intermediate deck dwell control quarter scroll

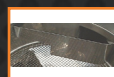

- Dwell control full scroll



- Mesh deblinding - mechanical



- Mesh deblinding - ultrasonic



- Hygiene base assy



- Hygiene vibro body & suspension



Finishes available

- Internal mirror polish to galleries (standard < 0.8Ra)
- Dressing of all internal/external welds
- Pharmaceutical mirror polish < 0.25Ra & dressing of all external welds
- Passivation after polish
- Vivateq/Sublimotion finish -whole machine
- Upgrade from earth clips to external direct mesh earthing system

CERTIFIED TECHNOLOGY



*More options available on request

1

2

3

4

5

6

THIRD ANGLE PROJECTION

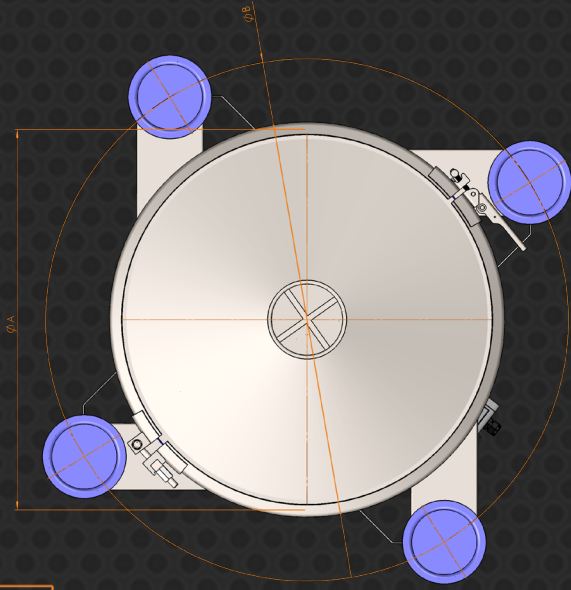

SM MULTISCREEN 800, 1200, 1500

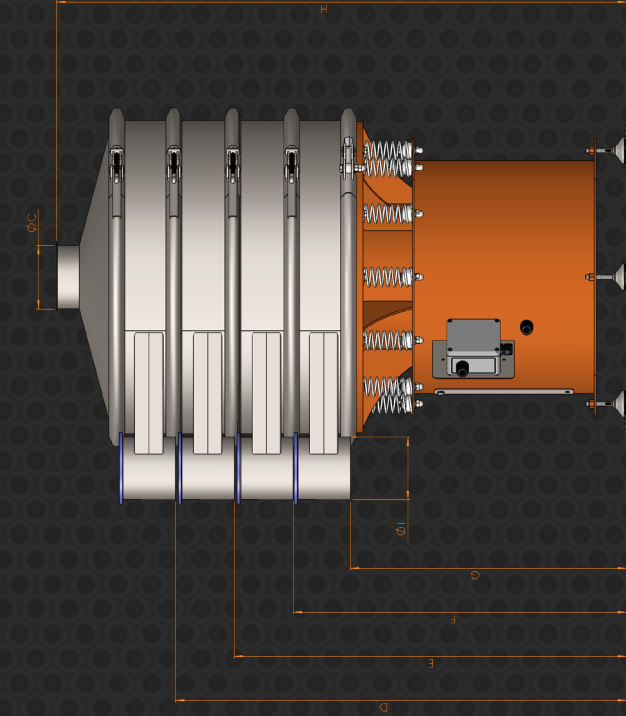
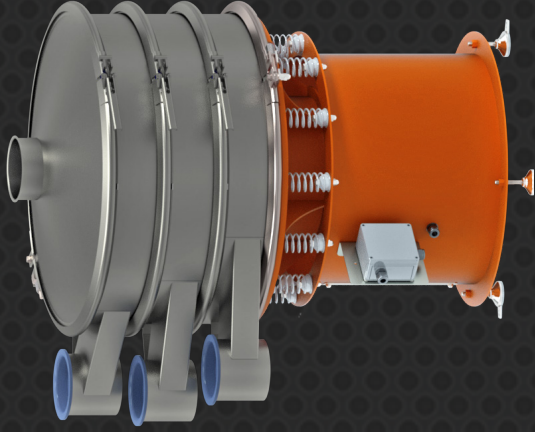

DIMENSION (mm)	A	B	C	D	E	F	G	H	I
SM800-P2	800	1100	160	160	---	815	675	1105	160
SM800-P3	800	1100	160	160	960	815	675	1250	160
SM800-P4	800	1100	160	1105	960	815	675	1395	160
SM1200-P2	1170	1690	250	---	---	860	690	1210	200
SM1200-P3	1170	1690	250	---	1035	860	690	1385	200
SM1200-P4	1170	1690	250	1210	1035	860	690	1560	200
SM1500-P2	1470	1820	250	---	---	890	690	1315	200
SM1500-P3	1470	1820	250	---	1095	890	690	1520	200
SM1500-P4	1470	1820	250	1300	1095	890	690	1725	200

SCREEN DIAMETER = REFER TO 'A' DIM

FLEXIBLE CONNECTIONS TO INLET & OUTLETS - MOBILE VERSION AVAILABLE.

ELECTRICAL	SM800	SM1200	SM1500
VOLTAGE	110 / 240 / 380-460	110 / 240 / 380-460	110 / 240 / 380-460
FREQUENCY	50 / 60 Hz	50 / 60 Hz	50 / 60 Hz
POWER	0.53 / 0.67 kW	0.90 / 1.05 kW	2.15 / 2.70 kW
PHASE	3	3	3
ATEX	YES	YES	YES